

PED-Board
just add power

Power Electronics & Drives Board V4

for National Instruments System on Module - sbRIO-9651[®]

HARDWARE and USER MANUAL

ped-board.com



I. Limited Warranty

This document is provided 'as is' and is subject to being changed, without notice, in future editions. For the latest version, refer to ped-board.com.

PED-Board team reviews this document carefully for technical accuracy; however, PED-Board team MAKES NO EXPRESS OR IMPLIED WARRANTIES AS TO THE ACCURACY OF THE INFORMATION CONTAINED HEREIN AND SHALL NOT BE LIABLE FOR ANY ERRORS.

PED-Board warrants that its hardware products will be free of defects in materials and workmanship that cause the product to fail to substantially conform to the applicable PED-Board specifications for one (1) year from the date of invoice.

Trademarks and service marks of third parties are the property of their respective owners.

Do not use in life support and medical applications. In such cases email to support@ped-board.com

Power Electronics & Drives Board • PED-Board V4

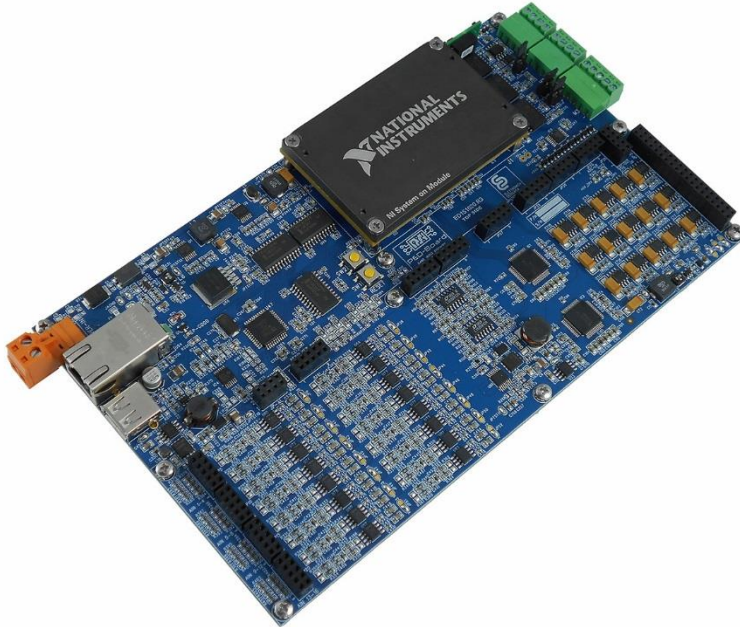

Applications

- Power electronics converters and electric drives
- Multilevel converter topologies
- Hybrid power systems
- UPS and PV converters
- High performance control algorithms
- High speed acquisitions and high throughput computation

Fully programmable by LabVIEW®.

Peripherals supported by dedicated LabVIEW® drivers.

Fully editable demo programs.

Features

- **30 x PWM channels**
 - 0÷15 V or 0÷5V selectable voltage swing
 - Direct LED driving capability for optocoupled gate driver
 - Additional PWM channels available through the Digital I/O interface
- **14-bit ADC, 8 Channels**
 - Simultaneous sampling
 - 1.45 μ s conversion time, 8 channels
 - Differential input
 - -5V÷5V or 0V÷10V configurable inputs
 - Second order low-pass Butterworth active filter with configurable cut-off frequency (factory default 20 kHz)
- **14-bit ADC, 8 Channels**
 - Simultaneous sampling
 - 1.45 μ s conversion time, 8 channels
 - Differential input
 - -5V÷5V or 0V÷10V configurable inputs
- **10-bit ADC, 8 Channels**
 - Up to 200 kS/s
 - 0V÷5V input
- **Lithium battery for the Real-Time clock (RTC Battery)**
- **12-bit DAC, 4 Channels**
 - Digital-to-analog converter with 10 μ s settling-time
 - Isolated, no ground loops
- **Resolver interface**
 - Fully configurable electrical interface
 - Speed and position measurement
 - Resolver fault detection
- **46 x Digital I/O, 3.3V standard**
 - Hall-effect position sensors interface
 - Encoder interface
 - Relay control
 - Additional PWM
 - General purpose I/O
 - Additional CAN controller
- **Ethernet (programming, debugging and operation)**
- **1 x RS-485**
 - Isolated transceiver
 - half-duplex and full-duplex communication
- **1 x CAN-bus**
 - 2.0A and 2.0B support
 - Isolated transceiver
 - Up to 1 Mbit/s
- **USB port**

Custom configuration for scaling circuits, filtering and default setup for orders of 5 units or more.



Functional block diagram

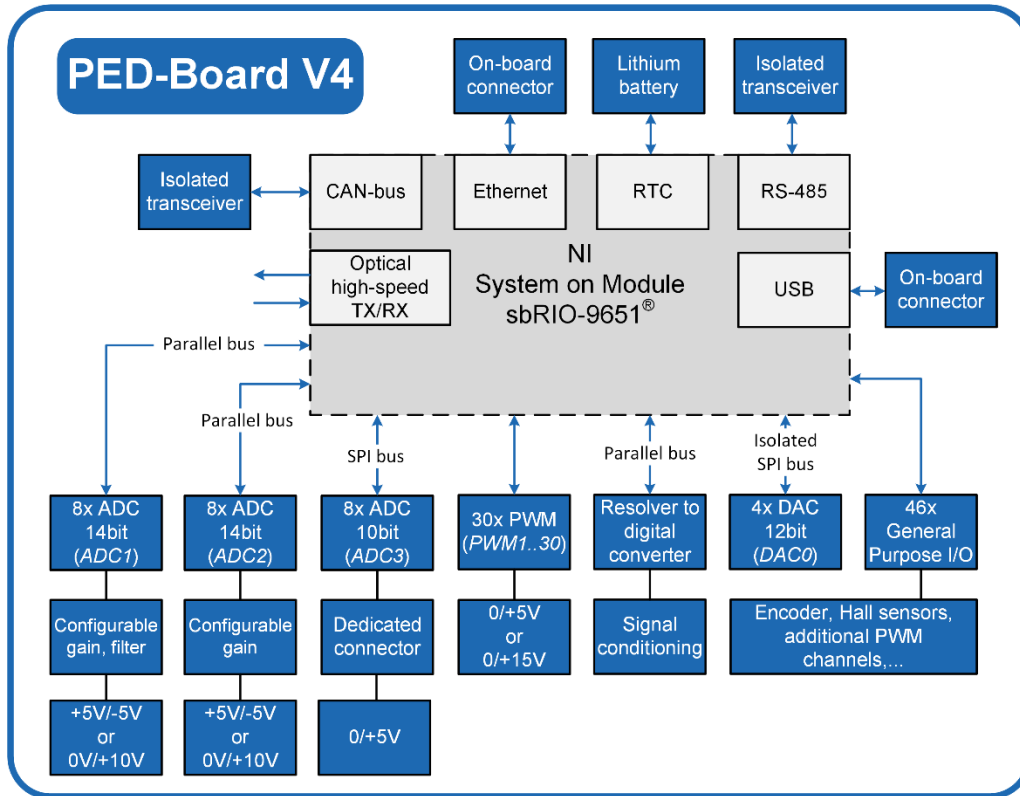

Table of contents

I.	LIMITED WARRANTY	2
II.	ELECTRICAL SPECIFICATIONS	5
III.	ANALOG-TO-DIGITAL CONVERTERS	5
A.	ADC1 INTERFACE	5
B.	ADC2 INTERFACE	7
C.	ADC3 INTERFACE	8
IV.	PWM CHANNELS (BUFFERED DIGITAL OUTPUTS)	9
V.	DIGITAL-TO-ANALOG INTERFACE	9
VI.	RESOLVER INTERFACE	10
VII.	CAN-BUS	11
VIII.	RS-485	12
IX.	DIGITAL I/O	12
D.	HALL SENSORS INTERFACE AND ENCODER PORT	13
X.	STATUS AND USER LEDS, USER BUTTON AND RESET, USB PORT	13
XI.	RTC BATTERY	13
XII.	OPTICAL LINK	13
XIII.	MECHANICAL DIMENSIONS	14
XIV.	MATE CONNECTORS	14
XV.	REFERENCES	14
XVI.	REVISION HISTORY	16



II. Electrical specifications

Recommended input voltage supply	+12	V	Vin - DC
Input voltage supply range	±10%		
<i>No reverse voltage protection</i>			
Input current	2.5	A	Max current at Vin
Storage temperature (IEC 60068-2-1, IEC 60068-2-2)	-40 to 85 °C		
Operating temperature	-25 to 60 °C		
Operating humidity (IEC 60068-2-56)	10 to 90% RH, noncondensing		
Storage humidity (IEC 60068-2-56)	5 to 95% RH, noncondensing		
Maximum altitude	5000	m	
Pollution Degree (IEC 60664)	2		
Analog inputs AINx (ADC1, ADC2) max voltage	±11	V	
Analog inputs AINx (ADC3) max voltage	+5.1	V	

Do not apply an input voltage higher than 14V at the Vin terminal with respect to GND.

- *Main power supply and auxiliary connectors*

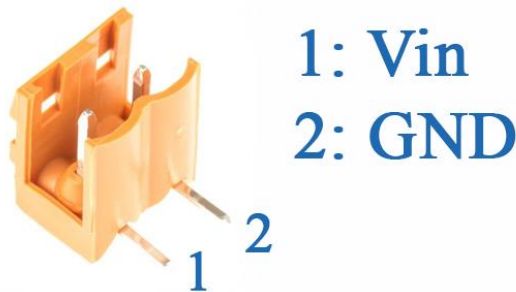

Figure 1. Pinout of the main power connector.

Power supply connector (OMNIMATE SL Weidmuller, RS code 403-998), mate connector available on Farnell with the code 1729275.

PED-Board is equipped with an auxiliary power connector, which can be used also from the application specific Adapter Board. Pinout is reported in Figure 2, where channels referred to AGND (+5V, ±12V) can provide up to 100mA each one, whereas the 12V (V_{out}) link up to 350mA.

JP-AL			
AGND	1	2	+5V
AGND	3	4	+12V
AGND	5	6	-12V
GND	7	8	12V (V _{out})

Figure 2. Connector for the auxiliary supply.

III. Analog-to-Digital converters

Analog to digital interface is based on three separate converters named respectively ADC1, ADC2 and ADC3. ADC1 and ADC2 have their dedicated scaling-filtering input circuit, with detailed explanation illustrated below. ADC3 inputs are provided without any interfacing hardware leaving to the final user their usage: temperature sensors, etc...

A. ADC1 interface

Analog-to-Digital Converter 1 (ADC1) is composed of 8 channels with simultaneous sampling capability and a resolution of 14 bit. Sampling and conversion for the 8 channels take around 1.45µs being capable of 600kS/s.

Filtering is performed by a fully configurable differential or single-ended input stage with a second order Butterworth type active filter. Scaling is accomplished by changing resistor values in the input stage, whereas filtering section has a fixed gain equal to one. Block scheme of ADC1 acquisition chain is shown in Figure 3.

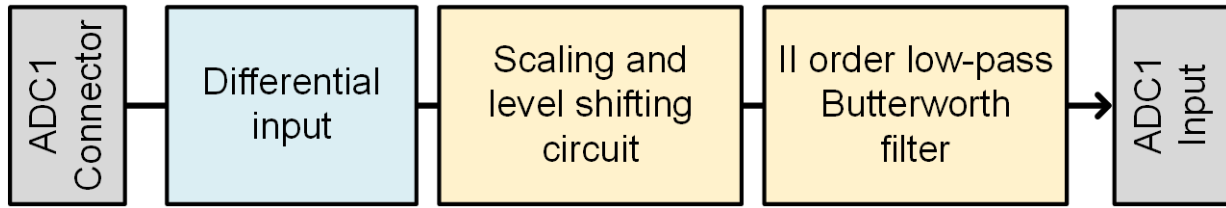

Figure 3. ADC1 measurement chain.

A level shifting circuit is provided to manage both unipolar and bipolar measurements. The analog connector input voltage range is $\pm 5V$ or $0V$ to $+10V$. Note, the maximum operating voltage at the ADC input is $\pm 11V$. The scaling circuit has an input to output gain, G_{SC} , equals to

$$G_{SC} = 1 + \frac{49.4k\Omega}{R_g} \quad (1)$$

where each resistor can be found according to Table 1.

Each analog input is fully differential. Level shifting circuit can be enabled for each analog channel. Bipolar measures are allowed to be sent to ADC in the range of $\pm 5V$ at the ADC input. In this case $0V$ input corresponds to $0V$ at the ADC pin. When unipolar input is desired, $0V$ at the input terminal corresponds to $-5V$ at the ADC terminal allowing the usage of the converter full scale without resolution deterioration. Selector vs. input is shown in Table 1. When pin 1 and pin 2 are shorted together, the resulting measure is unipolar, whereas pin 2 shorted to pin 3 results in bipolar input.

Table 1 – ADC1 configuring information

Analog input	R_g	Unipolar / Bipolar	
		1-2 unip.	2-3 bip.
AIN-1P / AIN-1N	R ₂₅₇	JP6 (2-3 default)	
AIN-2P / AIN-2N	R ₂₇₈	JP38 (2-3 default)	
AIN-3P / AIN-3N	R ₂₈₄	JP39 (2-3 default)	
AIN-4P / AIN-4N	R ₂₉₀	JP40 (2-3 default)	
AIN-5P / AIN-5N	R ₂₉₆	JP41 (2-3 default)	
AIN-6P / AIN-6N	R ₃₀₂	JP42 (2-3 default)	
AIN-7P / AIN-7N	R ₃₀₈	JP43 (1-2 default)	
AIN-8P / AIN-8N	R ₃₁₄	JP44 (1-2 default)	

Default values are $R_g = \text{not mounted}$, resulting in a gain of 1. Because of the resulting gain, the full-scale input voltage at the ADC1 connector is $\pm 5V$ for bipolar arrangement and $0 \div 10V$ for unipolar configuration.

ADC output data format is in two-complement, independently from the Unipolar/Bipolar scale selection. Retrieved data specifications are highlighted in Table 2. Accordingly, being the ADC resolution equals to 14-bits, resulting data DB [15:14] are set to zero for positive input voltage and one when negative voltage is applied.

Improved code efficiency and reduced FPGA occupancy can be obtained when 14-bits data input is considered using fixed-point signed data type, avoiding reading DB [15:14].

Table 2 – ADC output data format

Description	Input voltage value at the ADC input pin	Binary and hexadecimal code DB [15:0]
Positive full scale	+5V	0b 0001 111 1111 1111 0x 1FFF
Negative full scale	-5V	0b 1110 0000 0000 0000 0x E000

The pinout of the ADC1 input connector is shown in Figure 4. Each analog input must be connected between the related input P and N. Signal is converted considering the voltage difference P-N (maximum voltage on each pin is $\pm 11V$).

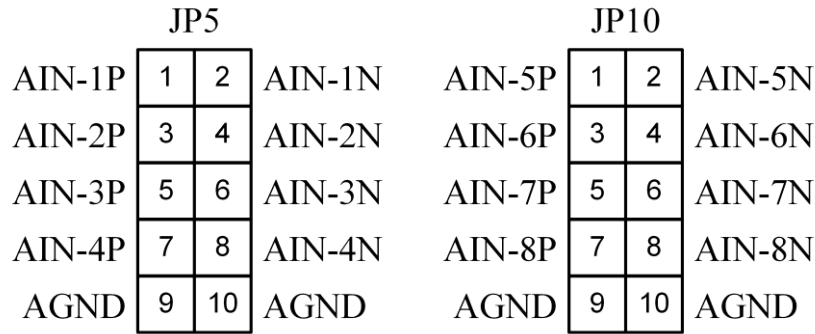

Figure 4. ADC1 connectors.

- *ADC1 filtering section*

The filtering section of ADC1 is accomplished by a II-order low-pass Butterworth type active filter, based on multiple-feedback topology. The PED-Board is shipped with a filter cut-off frequency set to 20kHz¹.

Please refer to Linear Technologies LT1359CS14 integrated circuit for frequency limitations and detailed filter characteristics.

When the filter cut-off frequency needs to be changed, please refer to the following information that are related to the PED-Board components that must be replaced. Each filter has the scheme shown in Figure 5 whereas the relation between the general element and the PED-Board component designator is reported in Table 3.

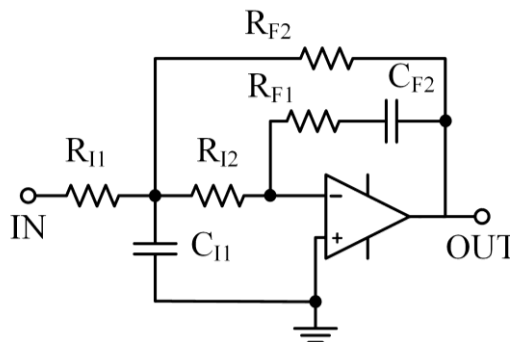

Figure 5. General electrical scheme of the II order Butterworth filter.

Table 3 – Board designators for the filter components

ADC1 channel	R _{I1}	R _{I2}	C _{I1}	R _{F1}	R _{F2}	C _{F2}
AIN-1	R ₉₇	R ₉₉	C ₁₃₉	Don't change	R ₂₂₈	C ₁₃₇
AIN-2	R ₁₀₂	R ₁₀₃	C ₁₄₃	//	R ₂₂₉	C ₁₄₁
AIN-3	R ₁₀₇	R ₁₀₆	C ₁₄₆	//	R ₂₃₁	C ₁₄₂
AIN-4	R ₁₀₁	R ₁₀₀	C ₁₄₀	//	R ₂₃₀	C ₁₃₈
AIN-5	R ₁₃₀	R ₁₃₁	C ₁₇₃	//	R ₂₃₂	C ₁₇₁
AIN-6	R ₁₃₄	R ₁₃₅	C ₁₇₇	//	R ₂₃₃	C ₁₇₅
AIN-7	R ₁₃₉	R ₁₃₈	C ₁₈₀	//	R ₂₃₅	C ₁₇₆
AIN-8	R ₁₃₃	R ₁₃₂	C ₁₇₄	//	R ₂₃₄	C ₁₇₂

B. ADC2 interface

The ADC2 interface is similar to the previously depicted ADC1, except the low-pass filter is eliminated to allow full bandwidth. The signal conditioning chain is highlighted in Figure 6. The input circuit devoted to scaling and level shifting exhibits the same gain as shown in equation (1). Each analog input is configured as differential. Moreover, all channels can be configured independently for unipolar or bipolar input. Detailed information available in Table 4.

¹ Custom filter configuration available for orders of 5 or more units.

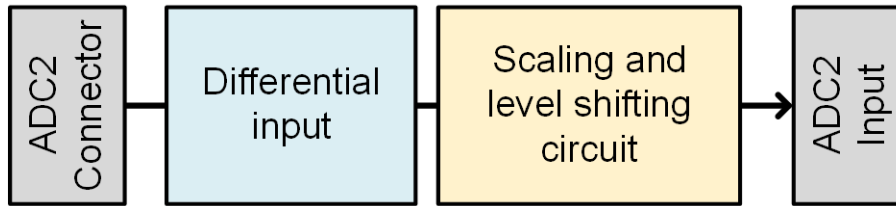

Figure 6. ADC2 measurement chain.

Table 4 – ADC2 configuring information

Analog input	R _g	Unipolar / Bipolar	
		1-2 unip.	2-3 bip.
AIN-9P / AIN-9N	R ₃₂₀	JP46 (2-3 default)	
AIN-10P / AIN-10N	R ₃₂₆	JP46 (2-3 default)	
AIN-11P / AIN-11N	R ₃₃₂	JP47 (2-3 default)	
AIN-12P / AIN-12N	R ₃₃₈	JP48 (2-3 default)	
AIN-13P / AIN-13N	R ₃₄₄	JP49 (2-3 default)	
AIN-14P / AIN-14N	R ₃₅₀	JP50 (2-3 default)	
AIN-15P / AIN-15N	R ₃₅₆	JP51 (1-2 default)	
AIN-16P / AIN-16N	R ₃₆₂	JP52 (1-2 default)	

ADC2 inputs are available on the PED-Board with reference to the pinout shown in Figure 7.

JP15			JP20				
AIN-9P	1	2	AIN-9N	AIN-13P	1	2	AIN-13N
AIN-10P	3	4	AIN-10N	AIN-14P	3	4	AIN-14N
AIN-11P	5	6	AIN-11N	AIN-15P	5	6	AIN-15N
AIN-12P	7	8	AIN-12N	AIN-16P	7	8	AIN-16N
AGND	9	10	AGND	AGND	9	10	AGND

Figure 7. ADC2 connectors.

C. ADC3 interface

Analog interface ADC3 is capable of low resolution, up to 200kS/s measures acquisition. Digitalization is performed by 10-bit on the available 8 channels. A SPI bus performs communication between the ADC3 and NI sbRIO-9651. ADC3 inputs are single-ended and available on the JP25 connector having the pinout shown in Figure 8. Analog input voltage swing is unipolar from 0V to +5V. At +5V the resulting output code is $2^{10}-1$. No signal conditioning or scaling is provided for ADC3 inputs.

JP25			
AIN-17	1	2	AIN-18
AIN-19	3	4	AIN-20
AIN-21	5	6	AIN-22
AIN-23	7	8	AIN-24
AGND	9	10	AGND

Figure 8. ADC3 connector.

IV. PWM channels (Buffered Digital Outputs)

Up to 30 independent PWM channels are provided through the connectors JP33, JP34, JP35 and JP36 having the detailed pinout of [Figure 9](#). Each channel that is composed by 10 PWM, can be configured to provide 0÷15 V or 0÷5 V voltage swing. When 0÷5V is selected, the PWM pin can directly drive the input LED of a classical opto-coupled gate driver, such as ACPL-333J or HCPL-316.

Voltage selection can be configured by JP2, JP3 and JP4 selectors. Connecting pin 2 to pin 1, each group is supplied from the on-board +5V with 15mA continuous current capability on each PWM output. Whereas connecting pin 2 to pin 3, PWM voltage swing is 0÷15V with 5mA continuous current on each PWM channel. JP2 controls PWM1 to PWM10, JP3 is related to PWM11 to PWM20 and finally JP4 configures PWM21 to PWM30, as summarized in [Table 5](#). PWM buffer circuit is non-inverting.

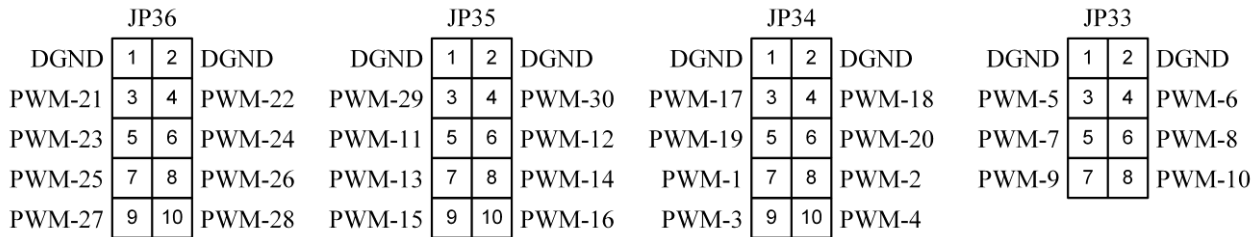

Figure 9. PWM connectors.

Table 5 – PWM voltage swing configuration²

	PWM1...PWM10 (JP2)	PWM11...PWM20 (JP3)	PWM21...PWM30 (JP4)
Position 1-2	+5 V (default)	+5 V (default)	+5 V
Position 2-3	+15 V	+15 V	+15 V (default)

Additional PWM outputs can be achieved from the *Digital I/O* pins, implementing the voltage and current driving circuits directly on the application specific [Adapter Board](#).

When each PWM channel needs to be controlled by a dedicated algorithm, NI sbRIO-9651 pins can be directly accessed using the following information ([Table 6](#)).

Table 6 – PED-Board and sbRIO-9651 PWM pin routing

PED-Board	sbRIO-9651	PED-Board	sbRIO-9651	PED-Board	sbRIO-9651
PWM-1	DIO_33_N	PWM-11	DIO_31	PWM-21	DIO_56_N
PWM-2	DIO_33	PWM-12	DIO_38_MRCC	PWM-22	DIO_59
PWM-3	DIO_30	PWM-13	DIO_28_N	PWM-23	DIO_59_N
PWM-4	DIO_37_MRCC	PWM-14	DIO_31_N	PWM-24	DIO_62_N
PWM-5	DIO_29	PWM-15	DIO_37_N	PWM-25	DIO_28
PWM-6	DIO_29_N	PWM-16	DIO_39_N	PWM-26	DIO_50_N
PWM-7	DIO_36_SRCC	PWM-17	DIO_34	PWM-27	DIO_53
PWM-8	DIO_36_N	PWM-18	DIO_39_SRCC	PWM-28	DIO_53_N
PWM-9	DIO_32_N	PWM-19	DIO_30_N	PWM-29	DIO_35_N
PWM-10	DIO_32	PWM-20	DIO_34_N	PWM-30	DIO_38_N

V. Digital-to-Analog interface

Digital to analog interface is based on a fast, low settling time converter with SPI interface. Output voltage, which swings from 0V to +5V, is isolated from the board ground, allowing to directly drive any output circuit avoiding ground loops. DAC resolution is 12 bits, starting from 0 to 4095 where the full output voltage is available. DAC connector shown in [Figure 10](#) provide also one isolated digital output channel, DO-ISO. DAC and DO-ISO are on the same ground. For faster usage of the DAC outputs, even with reduced channels, the connector shown in [Figure 11](#) is provided.

² Custom configuration available for orders of 5 or more units.



JP26			
DAC-A	1	2	GND-DAC
DAC-B	3	4	GND-DAC
DAC-C	5	6	GND-DAC
DAC-D	7	8	GND-DAC
DO-ISO	9	10	GND-DAC

Figure 10. Connector for DAC and Digital-Out pin.

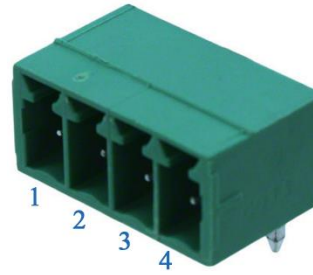

- 1: DAC-A
- 2: GND-DAC
- 3: DAC-B
- 4: GND-DAC

Figure 11. Fast DAC connector.

VI. Resolver interface

Resolver interface is mainly based on the Analog Devices AD2S1205YST integrated circuit. Differential excitation is provided with on-board current buffer. Sin/Cos acquiring circuits are designed to accomplish different type of resolvers, being equipped with a dedicated scaling circuit that can be configured by simply replacing some resistors. Carrier signal amplitude regulation is also allowed with a maximum peak voltage of 10V. Excitation driving circuit can directly supply resolvers based on rotary transformer or switched reluctance architecture. Scheme of the excitation circuit is shown in Figure 12 and it is reported in [1]. Both carrier signals, EXE+ and EXE- have the same amplification circuit. Detailed information on how to select the circuit component can be found in [1]. Resolver Sin/Cos acquiring circuit is shown in Figure 13, where three input resistors can be used to properly scale the resolver return signals. With reference to the PED-Board, Sin signal resistors are $R_{s1}=R_{182}$, $R_{s2}=R_{183}$ and $R_{s3}=R_{186}$. Accordingly, Cos resistors are $R_{s1}=R_{191}$, $R_{s2}=R_{192}$ and $R_{s3}=R_{195}$. More info can be found on Table 7 where the default values are also indicated. If the component value is not specified it stands for 'not mounted'. Resolver signals can be accessed by the JP27 connector as shown in Figure 14.

Table 7 – Resolver circuit components³

	EXE+	EXE-		Sin	Cos
R_{e1}	R_{197} (24 k Ω)	R_{199} (24 k Ω)	R_{s1}	R_{182} (5.6 k Ω)	R_{191} (5.6 k Ω)
R_{e2}	R_{236} (15 k Ω)	R_{238} (15 k Ω)	R_{s2}	R_{183} (12 k Ω)	R_{192} (12 k Ω)
R_{b1}	R_{241} (12 k Ω)		R_{s3}	R_{186} (5.6 k Ω)	R_{195} (5.6 k Ω)
R_{b2}	R_{243} (27 k Ω)				
C_{e1}	C_{324}	C_{325}			
R_{f1}	R_{239}	R_{240}			
C_{f1}	C_{327}	C_{328}			
R_{f0}	R_{237}				
C_{f0}	C_{326}				

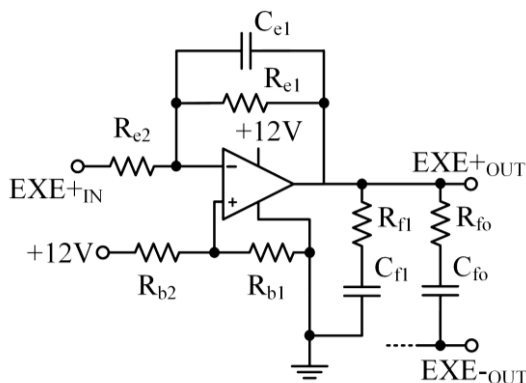

Figure 12. Electrical scheme of the resolver excitation circuit.

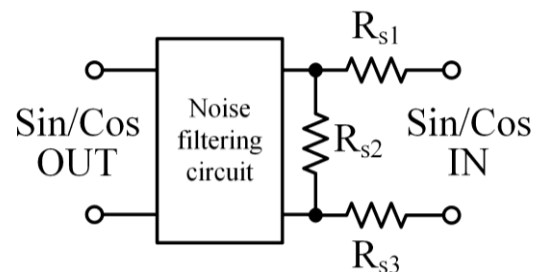

Figure 13. Resolver Sin/Cos scaling and acquiring circuit.

³ Custom resolver configuration available for orders of 5 or more units.

JP27

SIN+	1	2	EXE+
SIN-	3	4	EXE-
COS+	5	6	AGND
COS-	7	8	AGND
AGND	9	10	AGND

Figure 14. Resolver connector.

VII. CAN-bus

An isolated CAN transceiver having an operating data rate up to 1 Mbit/s has been integrated on the PED-Board. LabVIEW CLIP can straightforwardly realize the CAN controller if needed. However, it takes some FPGA resources resulting in an average estimation around 5.9% of Slice Registers, 12.5% of Slice LUTs and 10% of Block RAMs. No DSP48s resources are taken to implement the CAN controller. CAN connector is provided as shown in Figure 15.

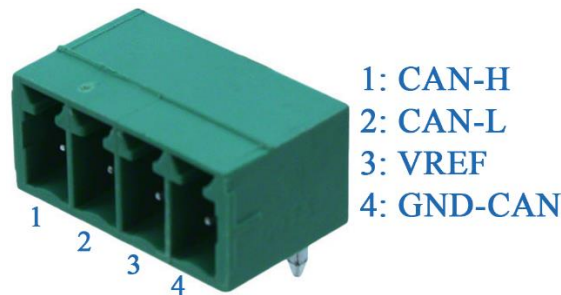

Figure 15. Fast CAN-bus connector

When CAN communication is not needed, FPGA space can be saved by removing the CAN controller from the generated CLIP.

CLIP generation requires the information concerning the sbRIO-9651 pins to be used as CAN TX and RX. Provided PED-Board CAN controller is connected as in Table 8.

Table 8 - Pin routing between the CAN-Bus transceiver and the sbRIO-9651

PED-Board	sbRIO-9651
CAN_TX	DIO_8
CAN_RX	DIO_9

R213 is used to setup the slope of the CAN-bus data (default 0 Ω). 120 Ω termination resistor can be inserted if needed, by closing the jumper JCAN.

- *II CAN controller*

A second CAN-bus controller can be implemented by the LabVIEW CLIP generator, and it will be available to the Digital I/O pins. The required transceiver must be placed directly on the *Adapted Board*.



VIII. RS-485

RS-485 port can be generated by the LabVIEW CLIP Generator. PED-Board is equipped with an isolated transceiver and a dedicated connector M3 having the pinout shown in Figure 16.

RS-485 CLIP can be generated according to the pin routing shown in Table 9.

Each TX and RX channel has its own 120 Ω termination resistor, which can be inserted by closing the jumper J485-H for RX and J485-F for TX. In case of half-duplex mode of operation, only one termination resistor should be closed.

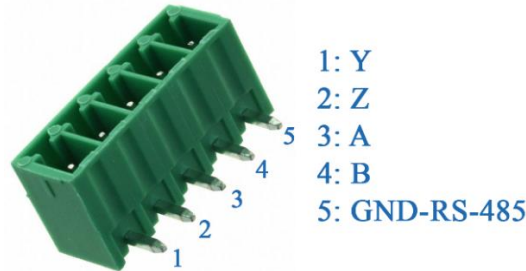

Figure 16. RS-485 connector.

Table 9 – Pin routing between the RS-485 transceiver and the sbRIO-9651

PED-Board	sbRIO-9651	
RS485_TX_EN	DIO_11	Transceiver TX enable pin
RS485_TX	DIO_10	Transceiver TX pin
RS485_RX	DIO_12	Transceiver RX pin
RS485_RX_EN	DIO_13	Transceiver RX enable pin

IX. Digital I/O

Additional I/O pins are available through JP29, JP30, JP31, JP32 and JP37 connectors that allow to route those pins directly to the *Adapter Board*. Connectors' pinout is highlighted in Figure 17. Digital I/O are directly connected to the ZYNQ-7020 pins, refers to the Xilinx device datasheet for the electrical specifications.

Additional Digital I/O pins are directly connected to the sbRIO-9651 FPGA pins. According to the National Instruments sbRIO-9651 datasheet, the relation between the PED-Board and sbRIO-9651 pins is as in Table 10.

JP29				JP30				JP31			
I/O_0	1	2	I/O_1	I/O_10	1	2	I/O_11	I/O_18	1	2	I/O_19
I/O_2	3	4	I/O_3	I/O_12	3	4	I/O_13	I/O_20	3	4	I/O_21
I/O_4	5	6	I/O_5	I/O_14	5	6	I/O_15	I/O_22	5	6	I/O_23
I/O_6	7	8	I/O_7	I/O_16	7	8	I/O_17	I/O_24	7	8	I/O_25
I/O_8	9	10	I/O_9	+3.3V	9	10	DGND	I/O_26	9	10	I/O_27
				JP32				JP37			
I/O_28	1	2	I/O_29	I/O_36	1	2	I/O_37	I/O_30	3	4	I/O_39
I/O_32	5	6	I/O_31	I/O_38	5	6	I/O_41	I/O_32	7	8	I/O_43
I/O_34	7	8	I/O_33	I/O_40	7	8	I/O_43	I/O_34	9	10	I/O_45
	+5V	10	I/O_35	I/O_42	9	10	I/O_45	DGND			

Figure 17. Digital I/O connectors.

Table 10. PED-Board vs. sbRIO-9651 digital I/O pins

PED-Board	sbRIO-9651	PED-Board	sbRIO-9651	PED-Board	sbRIO-9651	PED-Board	sbRIO-9651
I/O_0	DIO_25_N	I/O_12	DIO_24	I/O_24	DIO_49_N	I/O_36	DIO_19_N
I/O_1	DIO_0	I/O_13	DIO_21	I/O_25	DIO_46_N	I/O_37	DIO_72_N
I/O_2	DIO_25	I/O_14	DIO_24_N	I/O_26	DIO_70	I/O_38	DIO_69_N
I/O_3	DIO_1	I/O_15	DIO_43_N	I/O_27	DIO_46	I/O_39	DIO_44_N
I/O_4	DIO_22	I/O_16	DIO_47	I/O_28	DIO_70_N	I/O_40	DIO_47_N
I/O_5	DIO_19	I/O_17	DIO_43	I/O_29	DIO_67_N	I/O_41	DIO_2
I/O_6	DIO_22_N	I/O_18	DIO_48	I/O_30	DIO_71	I/O_42	DIO_3
I/O_7	DIO_20_N	I/O_19	DIO_44	I/O_31	DIO_67	I/O_43	DIO_4
I/O_8	DIO_23	I/O_20	DIO_48_N	I/O_32	DIO_71_N	I/O_44	DIO_5
I/O_9	DIO_20	I/O_21	DIO_45_N	I/O_33	DIO_68_N	I/O_45	DIO_6
I/O_10	DIO_23_N	I/O_22	DIO_49	I/O_34	DIO_72		
I/O_11	DIO_21_N	I/O_23	DIO_45	I/O_35	DIO_68		

D. Hall sensors interface and Encoder port

PED-Board is equipped with a digital interface for glue less connection of low-resolution hall-effect position sensors. These can be connected to the pins provided by the Digital I/O port, JP29, JP30, JP31, JP32 and JP37. As shown in [Figure 17](#), non-isolated +3.3V and +5V auxiliary supplies are provided, which can be used to directly feed hall-sensors and encoders with a maximum available current of 100mA each one.

X. Status and User LEDs, User button and Reset, USB port

PED-Board is equipped with three LEDs related to the sbRIO-9651 operation, POWER (green), STATUS (yellow) and TEMP (red). Please refer to the National Instruments System-On-Module datasheet for detailed explanation.

Additional user LEDs are provided, which can be controlled directly from the sbRIO-9651: LED1 (green) connected to the pin DIO_75 and LED2 (green) connected to DIO_81.

NI sbRIO-9651 can be reset by pressing SW1. SW2 can be used as user switch, having normally low state. It is connected to the DIO_87_SRCC pin of the sbRIO-9651 board.

USB port, formally USB1, can act only as HOST port.

XI. RTC Battery

PED-Board V4 is equipped with a Lithium battery for the Real Time Clock of the NI-SoM. It allows to not lose information about data even if the main power supply is off. Battery is a 3V, 35mA CR-1220 Lithium type.

XII. Optical Link

Table 11 – Pin routing for the optical link

PED-Board	sbRIO-9651	
TX	DIO_14	TX pin
RX	DIO_15_MRCC	RX pin

XIII. Mechanical dimensions

PED-Board size is 220mm x 130mm, same as the previous PED-Board systems. The mounting holes have not been changed.

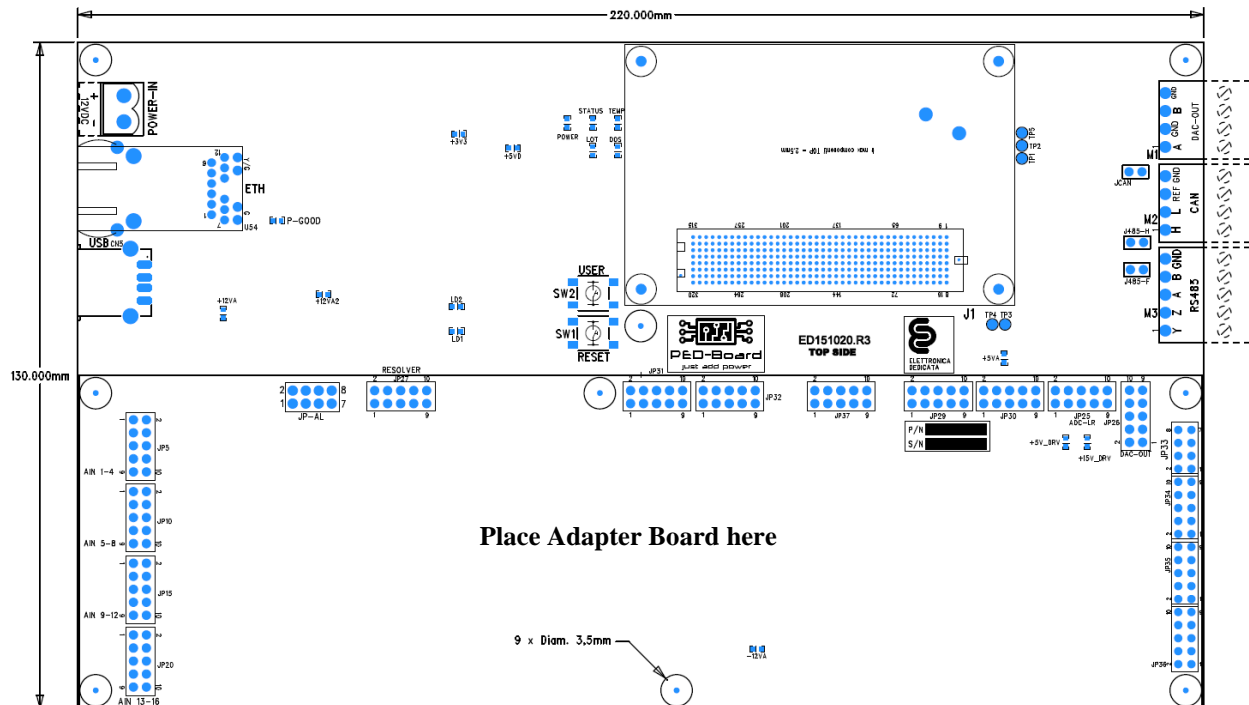

Figure 18. PED-Board mechanics.

Detailed mechanical information is available on-line in the [download](#) section.

Application specific Adapter Board must be placed above the board-to-board connectors, i.e. in the PED-Board bottom rectangle shown in Figure 18.

XIV. Mate connectors

Connector	Manufacturer	Distributor
Power supply *	WEIDMULLER 1526460000	Farnell 1729275
Strip line 2x4 (JP33, JP-AL, ...)	HARWIN M20-9980446	Mouser 855-M20-9980446
Strip line 2x5 (JP27, JP34, ...)	HARWIN M20-9980546	Mouser 855-M20-9980546
CAN-bus (screw) *	On Shore Technology Inc. OSTTJ0411530	DigiKey ED10556-ND
DAC (screw) *		
RS-485 *	Würth Elektronik 691361100005	DigiKey 732-2754-ND

* Mate connector shipped with the control board.

XV. References

- [1] Jakub Szymczak, Shane O'Meara, Johnny S. Gealon, and Christopher Nelson De La Rama, "Precision Resolver-to-Digital Converter Measures Angular Position and Velocity", Analog Devices application note.





XVI. Revision history

Date	Rev #	
Apr.1 st , 2023	1.0	

Use the PED-Board V4 with its dedicated LabVIEW CLIP. CLIPs from previous PED-board release (V3, V2 and V1) are not compatible and may damage the PED-Board V4.

Contacts

E.D. ELETTRONICA DEDICATA S.r.l.
Via dell'Industria 29/31, 25032 Chiari (BS) Italy
tel. +39 030 7281715

Support support@ped-board.com
Quote and purchase purchase@ped-board.com
General info info@ped-board.com